



Pressure Injectable PICC Product

Venous Access | Critical Care

ARROW®

Arrow International, Inc.

© 2008 Arrow International, Inc. All rights reserved. Printed in the USA.

An issued or revision date for these instructions is included for user information. In the event two years have elapsed between this date and product use, the user should contact Arrow International, Inc. to see if additional product information is available.

Issued Date: August 2015

Rx only.

Table of Contents

For convenience, procedural and general Warnings and Precautions are listed at the beginning of the instructions. Please review all content before performing the procedure.

| | |
|--|----|
| <i>Product Description</i> | 1 |
| Indications / Contraindications | 1 |
| <i>Pressure Injection</i> | 1 |
| Warnings and Precautions | 1 |
| Pressure Injection Procedure | 1 |
| <i>Peripherally Inserted Central Catheter Warnings and Precautions</i> | 2 |
| General | 2 |
| Catheter | 3 |
| Placement Wire & Guidewire | 4 |
| Tissue Dilator | 4 |
| Peel-Away Sheath over Tissue Dilator | 4 |
| Possible Complications | 4 |
| <i>Accessory Component Instructions</i> | 4 |
| Catheter Stabilization Device | 4 |
| Catheter Trimmer | 5 |
| Dressing | 6 |
| Echogenic Needle | 6 |
| Filter Straw | 7 |
| Guidewire / SWG Insertion Techniques | 7 |
| 80 cm | 7 |
| 130 cm | 7 |
| Maximal Barrier Drape | 7 |
| Positive Displacement Valve | 8 |
| Protected Needle | 9 |
| SharpsAway II™ Locking Disposal Cup | 9 |
| <i>Pre-PICC Insertion & Patient Assessment Activities</i> | 10 |
| Procedural Pause | 10 |
| Preparing for PICC Insertion | 10 |

For reference literature concerning patient assessment, clinician education, insertion techniques and potential complications associated with central venous access refer to Arrow International, Inc. website: www.arrowintl.com

| | |
|---|----|
| Prep Puncture Site | 10 |
| Prepare All Equipment | 10 |
| Trim Catheter | 11 |
| Flush Catheter | 11 |
| <hr/> | |
| <i>Catheter Insertion Instructions</i> | 11 |
| Gain Initial Venous Access | 11 |
| Sheath Placement | 12 |
| Catheter Advancement | 12 |
| Placement Wire | 12 |
| Verify Catheter Tip Placement | 12 |
| Complete Catheter Insertion | 12 |
| <hr/> | |
| <i>Documentation</i> | 13 |
| <hr/> | |
| <i>Care and Maintenance</i> | 13 |
| Dressing | 13 |
| Maintain Catheter Patency | 13 |
| <hr/> | |
| <i>Catheter Removal</i> | 14 |

Pressure Injectable Peripherally Inserted Central Catheter (PICC) Product

Product Description

The Arrow® Pressure Injectable PICC is a peripherally inserted central venous catheter (PICC) manufactured with medical grade, flexible polyurethane. The Arrow® PICC has a non-tapered catheter body with either a blunt tip or a Blue FlexTip® that is softer than a cut tip with a contour design to enhance maneuverability. The Blue FlexTip® also provides visual confirmation of an intact catheter upon removal. The kit components assist the clinician in maintaining maximal sterile barrier precautions.

Indications:

The Pressure Injectable PICC is indicated for short or long term peripheral access to the central venous system for intravenous therapy, blood sampling, infusion, and power injection of contrast media. The maximum pressure of power injector equipment used with the pressure injectable PICC may not exceed 300 psi.

Contraindications:

This device is contraindicated wherever there is presence of device related infections, previous or current thrombosis. Clinical assessment of patient must be completed to ensure no contraindications exists.

Pressure Injection

Warnings and Precautions:

Warnings:

1. Assess each patient for appropriateness of a power injection procedure.
2. Power injection procedures must be performed by trained personnel well versed in safe technique and potential complications.
3. Use an appropriate method to confirm catheter tip position prior to each pressure injection per institutional policy.
4. Ensure patency of catheter prior to power injection to minimize the risk of catheter failure and/or patient complications.
5. Discontinue power injections at first sign of infiltration / extravasation. Follow hospital protocol for appropriate medical intervention.

Cautions:

1. Do not exceed the maximum pressure of 300 psi on power injector equipment to minimize the risk of catheter failure and/or tip displacement.
2. Do not exceed 5 injections or the catheter's maximum recommended flow rate located on product labeling and catheter luer hub to minimize the risk of catheter failure and/or tip displacement.

3. Warm contrast media to body temperature prior to power injection to minimize the risk of catheter failure.
4. Pressure limit settings on power injector equipment may not prevent over pressurization of an occluded catheter.
5. Use an appropriately rated 60 inch pressure tubing between catheter and power injector equipment to minimize the risk of catheter failure.
6. Follow the specified contrast media manufacturer's instructions for use, warnings, precautions, and contraindications.

Pressure Injection Procedure:

NOTE: Clinicians should use sterile technique when flushing, disconnecting, connecting, and replacing injection/needleless caps.

1. Use an appropriate method to confirm each tip placement prior to each pressure injection per institutional policy.
2. Remove injection cap from the lumen of catheter to be injected.
3. Check for catheter patency:
 - Attach 10 mL syringe, or larger, filled with sterile normal saline.
 - Aspirate catheter until approximately 3 mL of blood enters syringe freely.
 - Vigorously flush catheter.

Warning: Ensure catheter patency prior to pressure injection to minimize the risk of catheter failure and/or patient complications.

4. Detach syringe.
5. Attach power injection equipment and extension tubing to lumen of catheter according to manufacturer's recommendations.

Caution: To minimize risk of catheter failure and/or tip displacement:

- Do not exceed the maximum pressure of 300 psi on power injector equipment.
- Do not exceed 5 injections or the catheter's maximum recommended flow rate located on product labeling and catheter luer hub.

6. Inject contrast media in accordance with hospital protocol.

Caution: Warm contrast media to body temperature prior to power injection to minimize the risk of catheter failure.

7. Disconnect catheter from power injector equipment.
8. Flush catheter with a 10 mL syringe, or larger, filled with sterile normal saline.
9. Replace sterile injection cap on catheter.

Peripherally Inserted Central Catheter

Warnings and Precautions:

Do not place the catheter into or allow it to remain in the right atrium or right ventricle (refer to Figure 1).



Figure 1

General Warnings and Precautions

Warnings:

1. Prior to use read all package insert warnings, precautions, and instructions. Failure to do so may result in severe patient injury or death.
2. Practitioners must be aware of complications associated with central vein catheters including but not limited to: cardiac tamponade secondary to vessel wall, atrial or ventricular perforation, pleural and mediastinal injuries, air embolism, catheter embolism, catheter occlusion, thoracic duct laceration, bacteremia, septicemia, thrombosis, inadvertent arterial puncture, nerve damage, hematoma, hemorrhage, and dysrhythmias.
3. Practitioners must be aware of clinical conditions that may limit use of PICCs including but not limited to: dermatitis, cellulitis, and burns at or about the insertion site, previous ipsilateral venous thrombosis, radiation therapy at or about insertion site, contractures, mastectomy, and potential use for AV fistula.
4. Do not place central venous catheter (CVC) or peripherally inserted central catheter (PICC) into or allow them to remain in the right atrium or right ventricle. X-ray exam or other method in compliance with hospital protocol must show catheter tip located in right side of mediastinum in the SVC (superior vena cava) above its junction with right atrium and parallel to vessel wall and its distal tip positioned at a level above either azygos vein or carina of the trachea, whichever is better visualized. Although cardiac tamponade secondary to pericardial effusion is uncommon, there is a high mortality rate associated with it. Improper advancement of guidewire into the heart has also been implicated in causing cardiac perforation and tamponade.

5. Ensure catheter tip has not entered the heart or no longer lies parallel to vessel wall by performing an x-ray exam or other method in compliance with hospital protocol. If catheter position has changed, immediately re-evaluate.
6. Practitioners must be aware of the potential for entrapment of guidewire by any implanted device in circulatory system (i.e., vena cava filters, stents). Review patient's history before catheterization procedure to assess for possible implants. Care should be taken regarding length of guidewire inserted. It is recommended that if patient has a circulatory system implant, catheter procedure be done under direct visualization to minimize the risk of guidewire entrapment.
7. Catheter tip must be located in central circulation when administering > 10% glucose solution, total parenteral nutrition, continuous vesicant therapy, infusates with pH less than 5 or greater than 9, and infusates with an osmolality above 600 mOsm/L, or any medication known to be irritating to vessels proximal to the vena cava.
8. Infusion of incompatible drugs through a non "staggered port" may cause precipitation.
9. Be aware of the risk of chemically induced thrombophlebitis when catheter is placed with distal end located in a vessel proximal to the SVC.
10. Do not leave open needles or uncapped, unclamped catheters in central venous puncture site. Air embolism can occur with these practices.
11. Use only securely tightened Luer-Lock connections with any Central Venous Access Device (CVAD) to guard against inadvertent disconnect.
12. Use Luer-Lock connectors to help guard against air embolism and blood loss.

Cautions:

1. The product is designed for single use only.
2. Do not resterilize or reuse.
3. Do not use if package has been previously opened or damaged.
4. Do not alter the catheter, guidewire, or any other kit/set component during insertion, use, or removal (except as instructed).
5. Procedure must be performed by trained personnel well versed in anatomical landmarks, safe technique, and potential complications.
6. Assess patient for heparin sensitivity. Heparin-induced thrombocytopenia (HIT) has been reported with the use of heparin flush solutions.
7. Do not routinely apply prophylactic topical antimicrobial or antiseptic ointment or cream to the insertion site of peripheral venous catheters because of the potential

- risk to promote fungal infections and antimicrobial resistance.
8. Temporarily shut off remaining port(s) through which solutions are being infused before blood sampling.
 9. Blood aspirate color is not always a reliable indicator of venous access.
 10. Do not reinsert needle into introducer catheter to minimize the risk of catheter embolism.
 11. Retract scalpel to protected position when not in use to minimize the risk of sharps injury.
 12. Perform hand hygiene before and immediately after all clinical procedures and before and after donning and removal of gloves.
 13. Properly dispose of sharps in sharps container in accordance with US OSHA or other governmental standards for blood borne pathogens and/or institutional policy.
 14. Hands must remain behind the needle at all times during use and disposal.
 15. Use universal blood and body-fluid precautions in the care of all patients due to the risk of exposure to HIV (Human Immunodeficiency Virus) or other blood borne pathogens.

Catheter Warnings and Precautions

Warnings:

1. For high pressure injection applications, only utilize catheters indicated for such applications. Catheters not indicated for high pressure applications can result in inter-lumen crossover or rupture with potential for injury.
2. Do not apply excessive force in placing or removing catheter. Failure to do so can result in catheter breakage. If placement or withdrawal cannot be easily accomplished, an x-ray should be obtained and further consultation requested.
3. Do not secure, staple, and/or suture directly to outside diameter of catheter body or extension lines to minimize the risk of cutting or damaging the catheter or impeding catheter flow. Secure only at indicated stabilization locations.
4. Do not cut catheter to alter catheter length unless procedure requires it.
5. Catheter clamp and fastener (where provided) must not be attached to catheter until either guidewire or placement wire is removed.
6. Do not use scissors to remove dressing to minimize the risk of cutting catheter.
7. Catheter clamp must be opened prior to infusion to minimize risk of damage to extension line(s) from excessive pressure.
8. Do not attempt to advance or reinsert placement wire (where provided) into catheter, through the septum, if placement wire has been removed prior to catheter insertion. Attempting placement wire advancement or reinsertion increases the risk of damaging catheter or wire.
9. Do not clamp extension line(s) when placement wire is in catheter to minimize the risk of placement wire kinking.
10. Slide clamp(s), where provided, may be inadvertently removed and aspirated by children or confused adults. In such situations, practitioners should remove slide clamp(s) when not in use.

Cautions:

1. Check ingredients of prep sprays and swabs before using. Some disinfectants used at catheter insertion site contain solvents which can attack the catheter material. Alcohol and acetone can weaken the structure of polyurethane materials. These agents may also weaken the adhesive bond between catheter stabilization device and skin.
 - Acetone: Do not use acetone on catheter surface.
 - Alcohol: Do not use alcohol to soak catheter surface or to restore catheter patency.

Take care when instilling drugs containing high concentration of alcohol. Allow insertion site to dry completely prior to applying dressing.
2. Do not use syringes smaller than 10 mL (a fluid filled 1 mL syringe can exceed 300 psi), to minimize the risk of pressure induced damage to catheter.
3. Prior to attempting a catheter exchange procedure, remove catheter clamp and fastener (where provided).
4. Do not exert excessive force while removing the catheter, to minimize the risk of catheter breakage.
5. Continuously monitor indwelling catheters for:
 - desired flow rate
 - security of dressing
 - adherence of stabilization device to skin and connection to catheter
 - correct catheter position; use centimeter markings to identify if catheter position has changed
 - secure Luer-Lock connection
6. Minimize catheter manipulation throughout procedure to maintain proper catheter tip position.
7. Provide strain relief of catheter under dressing to decrease catheter movement and assist in maintaining proper catheter tip position.
8. Inject a small amount of radiopaque dye to locate catheter tip if difficulty is encountered in visualizing the catheter tip.

Placement Wire & Guidewire / SWG Warnings and Precautions

Warnings:

1. Do not insert stiff end of guidewire into vessel as this may result in vessel damage.
2. Do not cut guidewire to alter length.
3. Do not withdraw guidewire against needle bevel to minimize the risk of possible severing or damaging of guidewire.
4. Do not use excessive force when introducing guidewire or tissue dilator as this can lead to vessel perforation and bleeding.
5. Passage of guidewire into the right heart can cause dysrhythmias, right bundle branch block, and a perforation of vessel wall, atrial, or ventricular.
6. Do not apply undue force on guidewire to minimize the risk of possible breakage.
7. Do not apply excessive force in removing guidewire or catheter. If withdrawal cannot be easily accomplished, a visual image should be obtained and further consultation requested.
8. Do not cut guidewire with scalpel.
 - Position cutting edge of scalpel away from guidewire.
 - Retract blade of safety scalpel to protected position once cutaneous puncture site is enlarged, to minimize the risk of cutting the guidewire.
9. Remove placement wire and Luer-Lock sidearm assembly as a unit. Failure to do so may result in wire breakage.

Caution:

1. Maintain a firm grip on guidewire at all times. Keep sufficient guidewire length exposed at hub for handling purposes. A non-controlled guidewire can lead to wire embolism.

Tissue Dilator Warnings

Warnings:

1. Do not leave tissue dilator in place as an indwelling catheter. Leaving tissue dilator in place puts patient at risk for possible vessel wall perforation.
2. Do not use excessive force when introducing guidewire or tissue dilator as this can lead to vessel perforation and bleeding.

Peel-Away Sheath over Tissue Dilator Precaution

Caution:

1. Do not withdraw dilator until sheath is within vessel to minimize the risk of damage to sheath tip.

Possible Complications:

- ◆ cardiac tamponade secondary to vessel wall, atrial or ventricular perforation
- ◆ pleural injury
- ◆ air embolism
- ◆ catheter embolism
- ◆ bleeding / hemorrhage
- ◆ bacteremia
- ◆ thrombosis
- ◆ hematoma
- ◆ brachial plexus injury
- ◆ fibrin sheath formation
- ◆ vessel erosion
- ◆ mediastinal injury
- ◆ nerve injury
- ◆ thoracic duct laceration
- ◆ occlusion
- ◆ septicemia
- ◆ inadvertent arterial puncture
- ◆ dysrhythmias
- ◆ exit site infection
- ◆ phlebitis
- ◆ catheter tip malposition

Accessory Component Instructions

Review the list of components that will be utilized before beginning the Arrow® Pressure Injectable PICC insertion procedure. Kits / Sets may not contain all accessory components detailed in this section. Become familiar with instructions for each individual component(s) before beginning the actual PICC insertion procedure.

The following components are listed alphabetically.

Catheter Stabilization Device:

STATLOCK® Catheter Stabilization Device should be used in accordance with manufacturer's instructions for use.

- Cleanse and prep anticipated dressing site per hospital/agency protocol. Skin prep should be applied to coat skin and maximize STATLOCK® adherence. Allow to dry thoroughly. The anchor pad will be placed so center of pad is within 1 to 1-1/2 inches (2.5 to 3.8 cm) of catheter insertion site.
- The catheter can be secured to STATLOCK® by using the primary suture hub.

Caution: Minimize catheter manipulation throughout procedure to maintain proper catheter tip position.

- Place suture hub wings over STATLOCK® posts and press down (refer to Figure 2). Snap STATLOCK® retainer wings to closed position to secure suture hub (refer to Figure 3).

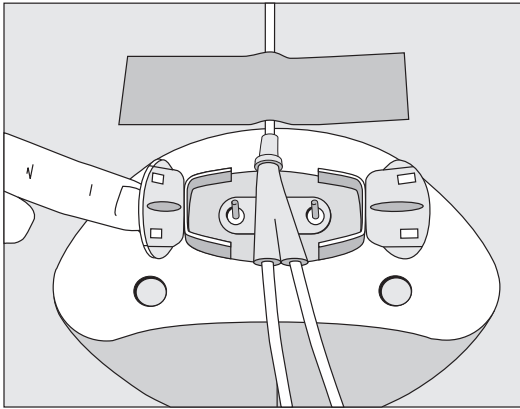

Figure 2

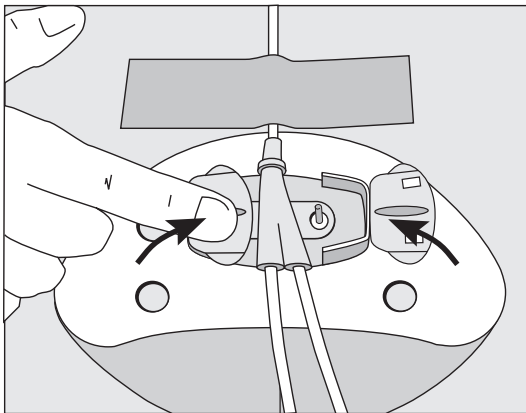

Figure 3

- Remove paper backing from one half of STATLOCK® Catheter Stabilization Device pad and press onto dry, prepared skin. Repeat process for other half of STATLOCK®.
- Complete sterile insertion site dressing according to established hospital/agency protocol.
- Document STATLOCK®/dressing application on patient's chart.
- Replace STATLOCK®/dressing per hospital/agency protocol. STATLOCK® Catheter Stabilization Device should be replaced at least every 7 days to ensure maximum adherence.

Catheter Trimmer:

NOTE: There should be very limited resistance when cutting catheter with supplied trimmer. Any greater resistance is likely to be caused by the placement wire – which has not been sufficiently retracted. If so, do not use catheter.

Catheter Trimmer is a one time use trimming device.

- To trim catheter with Catheter Trimmer, retract placement wire 1-1/2 inches minimum (4 cm) behind where catheter is to be cut. The placement wire is to be withdrawn through septum (see Figure 4).

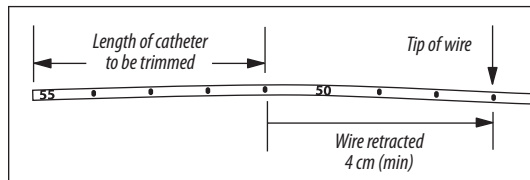

Figure 4

- Kink proximal end of placement wire at connector with sideport (see Figure 5). This minimizes the risk of placement wire extending beyond distal tip of catheter during insertion. (Do not attempt to advance placement wire through septum.)

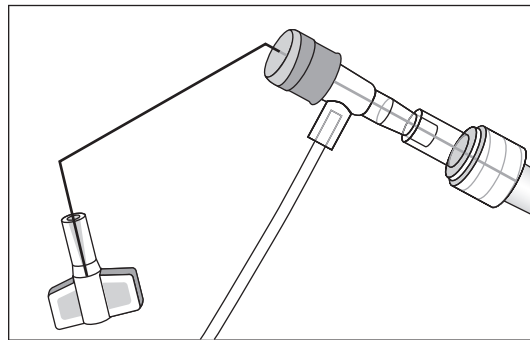

Figure 5

- Peel back contamination guard exposing catheter portion to be trimmed. Using trimming device, cut catheter straight across (90° to catheter cross-section) to maintain a blunt tip.

Warning: Do not cut placement wire when trimming catheter to minimize the risk of foreign embolism.

Caution: Check that there is no wire in cut catheter segment, after trimming catheter. If there is any evidence that placement wire has been cut or damaged, catheter should not be used.

Dressing:

Tegaderm™ IV Transparent Dressing:

- Prepare site. Allow all preps to dry completely.
- Peel liner from dressing to expose adhesive.
- Adhere center of transparent window over insertion site, while holding notched portion off the skin (refer to Figure 6).

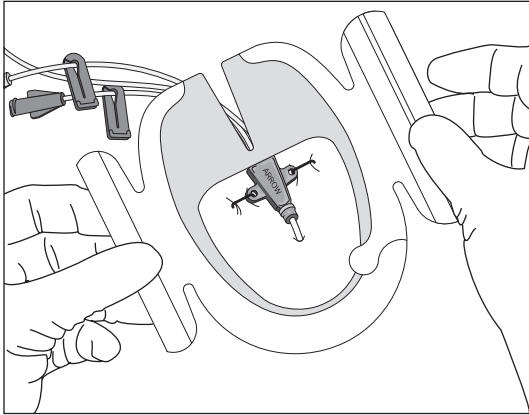

Figure 6

- Overlap softcloth tabs under catheter to form a tight seal around catheter hub and lumens (refer to Figure 7).

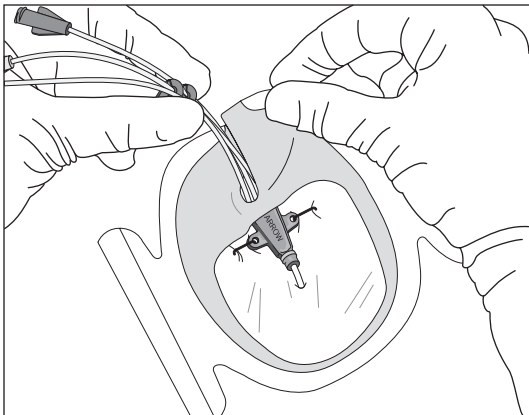

Figure 7

- Press dressing into place.
- Slowly remove frame while smoothing down dressing edges. Smooth dressing from center toward edges, use firm pressure to enhance adhesion (refer to Figure 8).

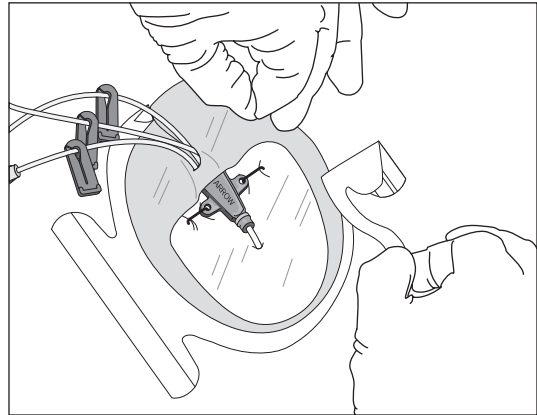

Figure 8

- Use sterile tape strips to secure hub, lumens, and/or tubing (refer to Figure 9).

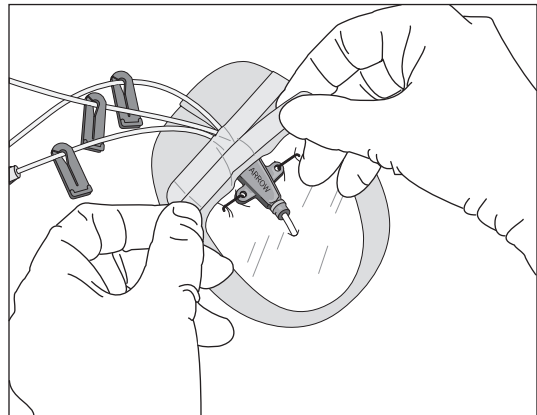

Figure 9

- Label dressing according to protocol.

Refer to individual manufacturer's instructions for more information and specific detailed instructions for dressing removal.

Echogenic Needle:

An echogenic needle is used to provide greater needle visibility under ultrasound. The needle tip is enhanced for approximately 1 cm for clinician to identify exact needle tip location when puncturing the vessel under ultrasound.

Filter Straw:

A filter straw is utilized to aspirate solution from glass ampule (5 micron) and minimize the risk of glass particulate from entering the solution.

- Open glass ampule using appropriate sterile and sharps protection technique.
- Attach filter straw to syringe.
- Insert filter straw into ampule.
- Aspirate contents from ampule.
- Remove and discard filter straw.
- Attach appropriate needleless connector or cannula to syringe.
- Purge air from syringe.
- Label syringe appropriately.

Guidewire / SWG Insertion Techniques:

Kits/Sets are available with a variety of Guidewires/SWG. Guidewires are provided in different diameters, lengths, and tip configurations for specific insertion techniques. Become familiar with the guidewire(s) to be used with the specific technique chosen, before beginning the actual PICC insertion procedure.

Image guidance may be used to gain initial venous access.

Catheter Insertion with an 80 cm Guidewire:

Use single 45 cm guidewire for venous access and 80 cm soft tip guidewire for catheter placement. Image guidance or fluoroscopy is used to gain initial venous access; catheter placement with 80 cm guidewire is done under fluoroscopy.

- Gain venous access with 45 cm guidewire and peel-away sheath.
- Load PICC onto 80 cm guidewire until soft tip of wire extends beyond tip of catheter.
- While maintaining control of distal end of guidewire, advance soft tip/catheter tip as a unit through peel-away sheath to desired depth.
- Once catheter is in desired location, remove guidewire.

Catheter Insertion with an 130 cm Guidewire:

Use single 45 cm guidewire for venous access and 130 cm soft tip guidewire for catheter placement. Image guidance or fluoroscopy is used to gain initial venous access; catheter placement with 130 cm guidewire is done under fluoroscopy.

- Gain venous access with 45 cm guidewire.
- Insert soft end of 130 cm guidewire through peel-away sheath to desired depth.
- Thread catheter over guidewire and advance catheter over guidewire through sheath into vessel into correct position.
- Once catheter is in desired location, remove guidewire.

NOTE: Some clinicians will gain access with 130 cm guidewire and thread catheter over guidewire once wire has been correctly positioned in the SVC. This technique is done under fluoroscopy.

Maximal Barrier Drape:

Drape(s) provide a maximal sterile barrier. Follow CDC Category 1A Recommendation.

- Drape provided is either:
 - Single extra-large drape with fenestration.
 - Two-piece drape consisting of an arm drape with fenestration and a body drape. The body drape is used to appropriately drape torso and upper-lower extremities.
- Unfold the Maximal Barrier Drape:
 - Peel off fenestration backing (refer to Figure 10).

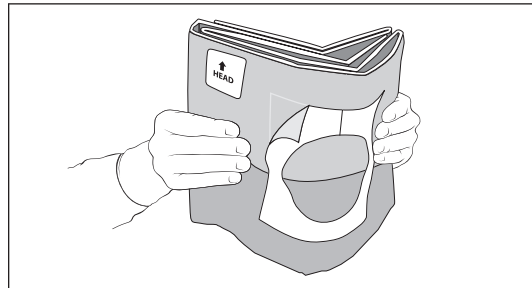

Figure 10

- Position fenestration over intended insertion site (refer to Figure 11).

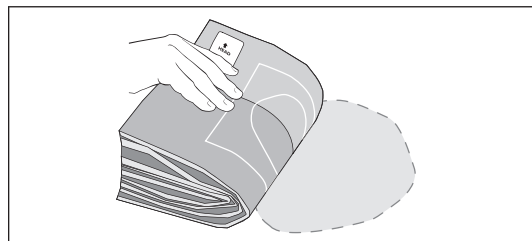

Figure 11

- Unfold width (refer to Figure 12).

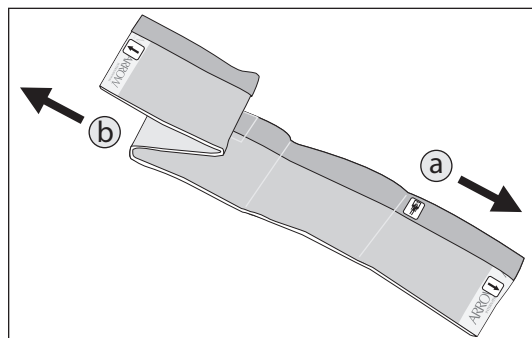

Figure 12

- Unfold towards head (refer to Figure 13).

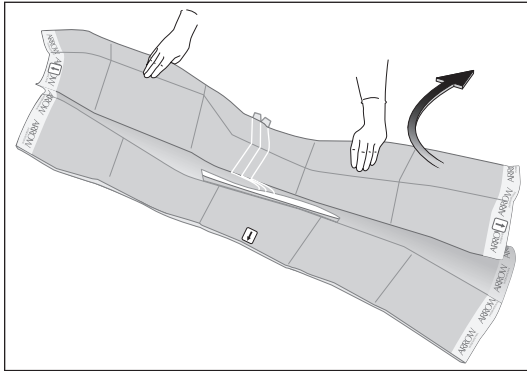

Figure 13

- Unfold towards hand (refer to Figure 14).

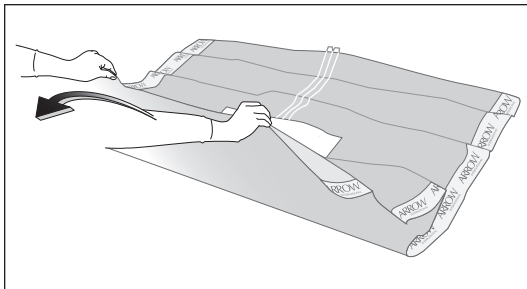

Figure 14

- Perform sterile procedure (refer to Figure 15).

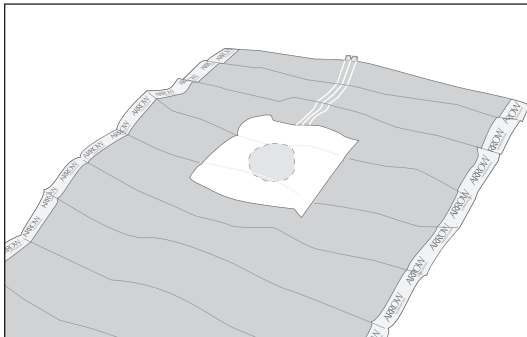

Figure 15

- Removal procedure: Tear along seam (refer to Figure 16).

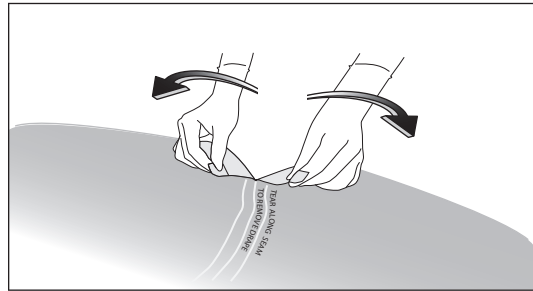

Figure 16

Positive Displacement Valve:

Positive displacement valves are needle-free injection ports utilized to minimize the risk of reflux of blood back into the catheter. Upon disconnection of syringe, a positive displacement of fluid will occur.

- Cleanse connector utilizing an appropriate antiseptic and friction prior to each use.
- Flushing should be done with an appropriately sized syringe.

Refer to individual manufacturer's instructions for specific details for priming volumes, dead space and flow rates.

CLC2000® Connector:

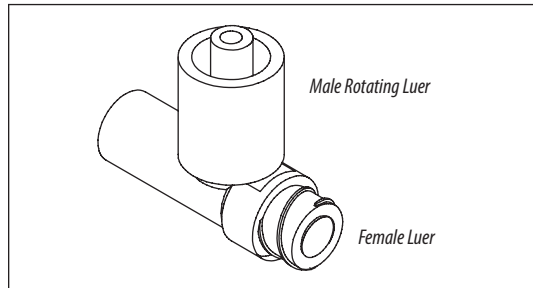

Figure 17

- Using aseptic technique remove CLC2000 from the package. Remove protective cap. Do not contaminate.
- Attach a syringe or administration set to female luer and prime CLC2000 in accordance with facility protocol. Invert device to expel air.
- Attach male rotating luer of CLC2000 to desired extension set or venous access device. Push and twist male rotating luer of CLC2000 into device until tight. Once the CLC2000 is secure, it may be rotated to achieve the most comfortable position on the patient's skin.

- To access CLC2000 swab female luer with desired disinfectant in accordance with facility protocol.
- Attach a fully primed syringe or administration set to CLC2000. Push and twist male luer of device into CLC2000 until tight. If using a rotating luer device, first push and twist Luer-Slip into CLC2000 until tight, then lock down the spin collar. This will ensure a secure connection and optimal flow rates.
- To disconnect from CLC2000, grasp CLC2000 and twist syringe or administration set away from CLC2000 until loose. DO NOT CLAMP catheter or extension set while disconnecting syringe or administration set from CLC2000, as it will interrupt the positive displacement.
- Flush the CLC2000 after each use with normal saline or in accordance with facility protocol.
- For subsequent connections repeat from step four.

Caution: DO NOT USE NEEDLES in the CLC2000.

Caution: DO NOT CAP CLC2000, device is closed.

Caution: DO NOT CLAMP the catheter prior to disconnecting a syringe from the CLC2000 as this will interrupt the positive displacement.

*CLC2000 is exclusively manufactured by ICU Medical, Inc.,
San Clement, CA 800-824-7890
949-366-2183 | www.icumed.com*

Protected Needle:

See individual manufacturer's instructions for product use, when used as a single product and not as a kit component.

Warning: Hands must remain behind needle at all times during use and disposal.

Caution: Make sure all needles are used in accordance with OSHA and hospital safety protocols.

Caution: Do not attempt to override or defeat the safety locking mechanism of a protected needle.

Caution: Discard in an approved sharps collector in accordance with applicable regulations and institutional policy.

SafetyGlide® Protected Needle:

- Aspirate medication into syringe using aseptic technique.
- If necessary to transport filled syringe to point of administration, use safe, passive recapping technique to cover needle before transport to point of use. In accordance with OSHA standards, such recapping must be accomplished by a one-handed technique, i.e., do not hold needle shield during recapping process.
- Administer injection following established technique.
- Immediately activate needle protection device upon withdrawal from patient by pushing lever arm completely forward until needle tip is fully covered (see Figure 18).

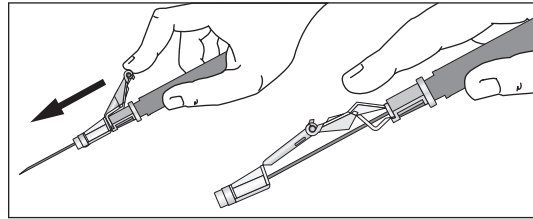

Figure 18

- Visually confirm lever arm has fully advanced and needle tip is covered. If unable to activate, discard immediately into approved sharps collector.
- Activation of protective mechanism may cause minimal splatter of fluid that may remain on needle after injection.
- After single use, discard in an approved sharps collector in accordance with applicable regulations and institutional policy. For greatest safety, use a one-handed technique and activate away from self and others.

SharpsAway II™ Locking Disposal Cup:

The SharpsAway II™ Locking Disposal Cup is used for disposal of needles (15 Ga. - 30 Ga.).

- Using one-handed technique, firmly push needles into disposal cup holes (refer to Figure 19).

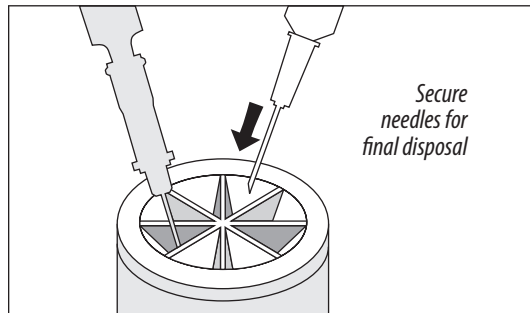

Figure 19

- Once placed into disposal cup, needles will be automatically secured in place so that they cannot be reused.
- Discard entire cup, at completion of procedure, into an approved sharps container.

Caution: Do not attempt to remove needles that have been placed into SharpsAway II™ Locking Disposal Cup. These needles are secured in place. Damage may occur to needles if they are forced out of disposal cup.

- Where provided, a foam SharpsAway® system may be utilized by pushing needles into foam after use.

Caution: Do not re-use needles after they have been placed into the foam SharpsAway® system. Particulate matter may adhere to needle tip.

Pre-PICC Insertion & Patient Assessment Activities

Perform hand hygiene as required.

A procedural checklist is included on back of product label.



Procedural Pause:

- Verify physician order:
 - Confirm correct patient.
 - Confirm correct diagnosis.
 - Confirm correct procedure.

Physician order must include post placement assessment of catheter tip placement (x-ray exam or other method in compliance with hospital protocol).
- Patient education: Explain procedure to patient. Make sure information is presented with respect to patient's level of understanding, culture, and language.
- Have informed consent signed, if required.
- Identify insertion vein:
 - Apply tourniquet above anticipated insertion vein.
 - Identify appropriate vein for insertion. Use direct visualization technologies, if available, and assess vein health.

NOTE: PICCs are typically inserted into basilic, brachial, or cephalic veins (refer to Figure 20).

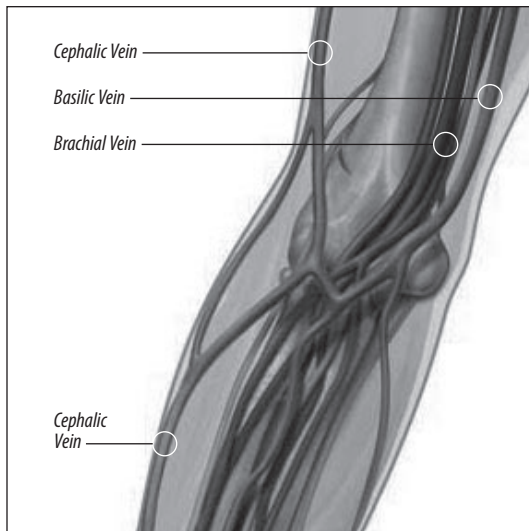

Figure 20

- Release tourniquet and leave in place beneath the arm.
- Measure patient to assure placement of catheter in the SVC:
 - Extend arm laterally 45 to 90 degrees from trunk.
 - Measure distance from insertion site along presumed anatomical course of vessel to be catheterized.
 - Catheter tip should lie in distal one-third of SVC above right atrium and parallel to SVC wall.
 - If a catheter stabilization device will be used, add ½ to 1 inch (1.2 to 2.5 cm) to catheter measurement (STATLOCK®); if another device is used, check manufacturer recommendations.
 - If using upper arm circumference assessment; for consistency in measurement, measure from an anatomical point and record.
- Position patient as appropriate for insertion site:
 - Extend arm laterally 45 to 90 degrees from trunk.
- Prepare work area.

Preparing for PICC Insertion:

- Perform hand hygiene as required:
 - before and immediately after all clinical procedures
 - before and after donning and removal of gloves
- Use universal blood and body-fluid precautions in the care of all patients due to the risk of exposure to HIV (Human Immunodeficiency Virus) or other blood borne pathogens.
- Handle and dispose of sharps appropriately in accordance with state/federal OSHA standards for blood borne pathogens and/or institutional policy.
- Clinicians should use sterile technique, maximal sterile barrier precautions throughout the procedure, and dress in protective clothing:
 - mask
 - sterile gown
 - hair cover
 - eye protection
 - sterile gloves

Prep Puncture Site:

- Prep and drape peripheral puncture site.
- Perform skin wheal with a local anesthetic as needed.
- In kits where provided, the SharpsAway II™ Locking Disposal Cup is used for disposal of needles (15 Ga. - 30 Ga.).

Caution: Do not attempt to remove needles that have been placed into SharpsAway II™ Locking Disposal Cup. These needles are secured in place. Damage may occur to needles if they are forced out of disposal cup.

Prepare All Equipment:

Prepare Catheter with Placement Wire for Insertion (where provided) (refer to Figure 21).

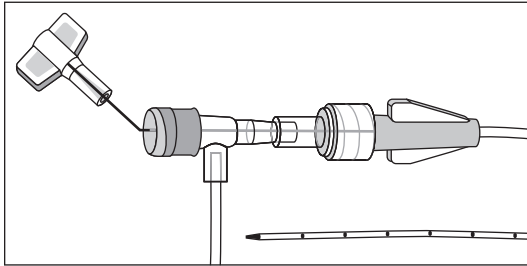

Figure 21

- Remove catheter tip protector.

Trim Catheter:

If necessary, review detailed instructions for Catheter Trimmer device under Accessory Component Instructions section.

1. Identify catheter type:
 - BFT (Blue FlexTip®)
 - Non-BFT
2. Peel back contamination guard exposing catheter portion to be trimmed.
3. Review catheter marking pattern below. The catheter is marked so clinician can easily identify desired amount of catheter to be trimmed; length of catheter that remains or as with BFT catheter – both.
 - BFT double numbering pattern:

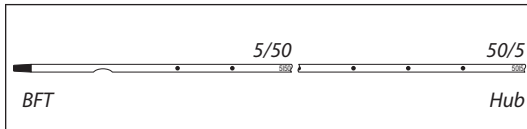

Figure 22

- ◇ First number designates centimeters from tip of catheter.
- ◇ Second number designates centimeters from hub of catheter.
- ◇ This double numbering pattern permits clinician to easily identify centimeters of catheter to be trimmed and also identifies centimeters of catheter remaining.
- ◇ Record both numbers.

- Non-BFT numbering pattern:

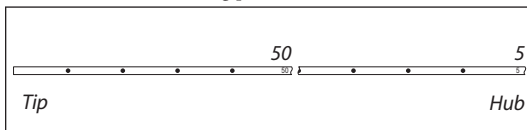

Figure 23

- ◇ Number designates centimeters of catheter to be trimmed and also gives amount of catheter remaining.

4. Using the trimming device, cut catheter straight across (90° to catheter cross-section) to maintain a blunt tip. **NOTE: There should be very limited resistance when cutting catheter with supplied trimming device. If using a catheter with a placement wire, any greater resistance is likely to be caused by the placement wire which has not been sufficiently retracted. If so, do not use catheter.**
5. Inspect cut surface for clean cut and no loose material.

Warning: Do not cut placement wire when trimming catheter to minimize the risk of foreign embolism.

Caution: Check that there is no wire in cut catheter segment, after trimming catheter. If there is any evidence that placement wire has been cut or damaged, catheter should not be used.

Flush Catheter:

1. Use filter straw to withdraw solution from glass ampules.
2. Attach syringe to sidearm and flush distal lumen with sterile saline solution. Leave syringe in place.
3. Flush remaining lumen(s) with sterile saline. Clamp or attach injection site cap(s) to extension line(s) to contain saline within lumen.

Catheter Insertion Instructions

1. Reapply tourniquet and replace sterile gloves.
2. Locate vein for insertion:
 - Use image guidance, if available.
 An echogenic needle is included for access.
3. Insert introducer needle into vein.

Check for pulsatile flow. Pulsatile flow is usually an indicator of inadvertent arterial puncture.

Caution: The color of blood observed is not always a reliable indicator of venous access.

Gain Initial Venous Access:

See specific guidewire instructions, Guidewire Insertion Techniques (page 7) under Accessory Component Instructions section.

1. Insert soft tip of guidewire through introducer needle into vein. Advance guidewire to desired depth.

Warning: Do not insert stiff end of soft tip guidewire into vessel as this may result in vessel damage.

Warning: Do not cut guidewire to alter length.

Warning: Do not withdraw guidewire against needle bevel to minimize the risk of possible severing or damaging of guidewire.

2. Remove needle:

Hold guidewire in place while removing introducer needle.

Caution: Maintain firm grip on guidewire at all times.

3. Enlarge puncture site, if necessary:

Use scalpel positioned away from the guidewire to enlarge cutaneous puncture site. Do not cut guidewire. Retract scalpel to the protected position.

Sheath Placement:

1. Thread tapered tip of peel-away sheath/dilator assembly over guidewire. Grasping near skin advance assembly with slight twisting motion to a depth sufficient to enter vessel. Dilator may be partially withdrawn to further facilitate advancement of sheath into the vessel. A slight twisting motion of the peel-away might help sheath advancement.

Caution: Do not withdraw tissue dilator until the sheath is well within the vessel to minimize the risk of damage to sheath tip. Sufficient guidewire length must remain exposed at hub end of sheath to maintain a firm grip on guidewire.

2. Check sheath placement by holding sheath in place, withdraw guidewire and dilator sufficiently to allow venous blood flow. Holding sheath in place, remove guidewire and dilator as a unit.

Warning: Do not leave the dilator in place as an indwelling catheter to minimize the risk of possible vessel wall perforation.

Warning: Do not apply undue force on guidewire to minimize the risk of possible breakage.

Catheter Advancement:

Advance catheter according to the guidewire used. Review detailed instructions for 80 cm and 130 cm guidewire usage (page 7) under Accessory Component Instructions section.

Warning: Do not apply excessive force in placing or removing catheter. Failure to do so can result in catheter breakage. If placement or withdrawal cannot be easily accomplished, an x-ray should be obtained and further consultation requested.

1. Retract catheter guard.
2. Insert catheter through peel-away sheath.
 - If resistance is met while advancing catheter, retract and/or gently flush while advancing.
3. Stop advancing catheter 5 inches (13 cm) before reaching pre-established insertion length.
4. Withdraw peel-away sheath over catheter until free from venipuncture site.
5. Grasp tabs of peel-away sheath and pull apart, away from catheter, until sheath splits down entire length.
6. Advance catheter to final indwelling position.

Placement Wire (where provided):

Caution: To minimize the risk of placement wire kinking, do not clamp extension line(s) when placement wire is in catheter.

1. Complete catheter insertion.
2. Remove placement wire.

Warning: Remove placement wire and Luer-Lock sidearm assembly as a unit (see Figure 24). Failure to do so may result in wire breakage.

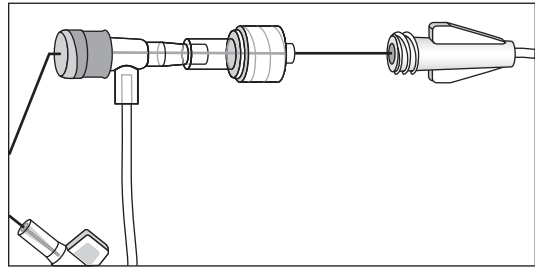

Figure 24

Caution: Catheter clamp and fastener (if provided and used) must not be attached to catheter until either guidewire or placement wire is removed.

Verify Catheter Tip Placement:

1. Examine tip of placement wire after removal to ensure wire has not been altered (see Figure 25).

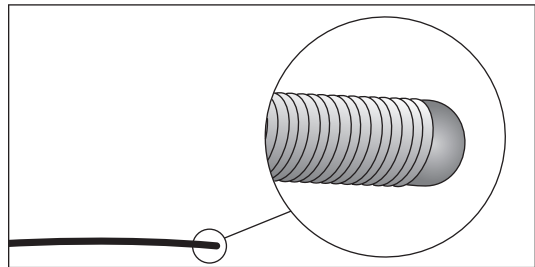

Figure 25

2. If there is any indication placement wire is damaged, catheter and placement wire should be removed together.
3. Check catheter placement with syringe by aspirating through distal lumen until free flow of venous blood is observed.

Caution: The color of blood is not always a reliable indicator of venous access.

Complete Catheter Insertion:

1. Flush lumen(s) to completely clear blood from catheter.
2. Connect extension line(s) to appropriate Luer-Lock line. Alternately, port(s) may be "locked" through injection cap(s) using standard hospital/agency protocol. Slide clamp(s) is provided on extension line to occlude flow through lumen during line and injection cap changes.

Warning: Slide clamp(s), where provided, may be inadvertently removed and aspirated by children or confused adults. In such situations, practitioners should remove slide clamp(s) when not in use.

3. Cleanse insertion site per hospital/agency protocol.

Caution: Do not routinely apply prophylactic topical antimicrobial or antiseptic ointment or cream to the insertion site of peripheral venous catheters because of the potential risk to promote fungal infections and antimicrobial resistance.

4. Ensure insertion site is dry before applying dressing. Apply skin protectant as needed.
5. Secure catheter. Where provided, a catheter clamp, fastener, catheter stabilization device or Steri-Strip® may be used.
6. Assess placement of catheter tip in compliance with hospital protocol.

Documentation

Institutions must establish a permanent medical record that documents the entire procedure, based upon their policy, procedures, and Best Practices. The actual format can differ from institution to institution. Report any product defects/failures to organization risk management, manufacturers, and appropriate regulatory agencies.

Documentation generally includes (but is not limited to) the following information:

1. Device specifics:
 - type, brand and lot number
 - length and size of Vascular Access Device (VAD)
 - internal/external catheter length
 - whether catheter is trimmed
2. Procedure specifics:
 - time out or procedural pause
 - informed consent, as required
 - date, time of insertion, insertion site, number and site attempts, inserter's identification
 - use of visualization and guidance technologies
 - site preparation and technique
3. Patient assessment and response:
 - pertinent dx, assessment, vital signs
 - understanding of procedure, patient's response to procedure
 - complications and barriers to care
4. Therapy specifics:
 - type of therapy, drug dose, rate, time
 - route and method of administration
 - laboratory specimen collected
5. Visual confirmation:
 - verification of appropriate tip location prior to initial use
6. Monitor patient for post catheter insertion complications.

Care and Maintenance

Dressing:

Replace dressing according to organizational policies, procedures, and practice guidelines. Change immediately if the integrity becomes compromised e.g. dressing becomes damp, soiled, loosened, or no longer occlusive.

- Consult manufacturer's recommendations for dressing specifics.
- Transparent semipermeable membrane dressing should be changed every 7 days.
- Gauze and tape should be changed every 48 hours.
- Label dressing with type, size, and length of catheter; date and time; and initials of the clinician performing dressing change.

Maintain Catheter Patency:

Maintaining central venous catheter patency shall be done in accordance with organizational policies, procedures, and practice guidelines. All personnel who care for patients with central venous catheters must be knowledgeable about effective management to prolong catheter's dwell time and prevent injury.

Perform hand hygiene as required.

1. Solution and frequency of flushing a venous access catheter should be established in hospital/agency policy.
2. Catheter patency is established and maintained by:
 - flushing intermittently via syringe with heparinized saline or preservative-free 0.9% sodium chloride (USP)
 - continuous drip
 - positive pressure device
3. The amount of heparin:
 - depends on physician preference,
 - hospital/agency protocol,
 - patient condition

Caution: Assess patient for heparin sensitivity. Heparin-induced thrombocytopenia (HIT) has been reported with the use of heparin flush solutions.

4. The volume of flush solution should be:
 - equal to at least twice the priming volume of the catheter and any add-on devices

Catheter priming volume is printed on product packaging.
5. When using any central venous catheter for intermittent infusion therapy, proper flushing (heparinization) using a positive-pressure flushing technique will help prevent occlusion. Neutral as well as positive displacement valve systems have also been shown to help prevent occlusion.
6. All valves need to be properly cleansed with an appropriate antiseptic before being accessed.
7. The SASH or SAS method of flushing will help eliminate occlusions due to incompatible solutions:
 - Saline • Administer drug • Saline • Heparin (if used)

Catheter Removal Procedure

1. PICC removal shall be performed:
 - following order of authorized prescriber
 - in accordance with organizational policies, procedures, and practice guidelines
2. A PICC shall be removed immediately upon patient assessment for:
 - suspected contamination
 - unresolved complication
 - discontinuation of therapy

3. As indicated, place patient in supine position to minimize the risk of potential air embolism.

4. Remove dressing.

Warning: Do not use scissors to remove dressing, to minimize the risk of cutting catheter.

5. Open catheter stabilization device retainer wings and remove catheter from catheter stabilization device posts.

6. Remove catheter by slowly pulling it parallel to skin. If resistance is met when removing the catheter, catheter should not be forcibly removed and the physician should be notified.

Caution: Do not exert excessive force while removing the catheter; to minimize the risk of catheter breakage.

7. Upon removal of catheter:

- measure and inspect
- ensure entire catheter length has been removed

8. Direct pressure should be applied at site until hemostasis is achieved.

9. Apply alcohol swab to catheter stabilization device adhesive and gently lift pad off of skin (if applicable).

10. Dress insertion site. Sterile occlusive dressing should be applied and site assessed every 24 hours until site is epithelialized. Residual catheter track may remain an air entry point until completely sealed (usually 24 to 72 hrs); dependent upon amount of time catheter was indwelling.

11. Document catheter removal procedure on patient's chart per hospital/agency protocol.

Include:

- catheter condition
- length of catheter removed
- patient's tolerance of the procedure
- any nursing interventions needed for removal

For reference literature concerning patient assessment, clinician education, insertion techniques and potential complications associated with central venous access refer to Arrow International, Inc. website: www.arrowintl.com



2400 Bernville Road, Reading, PA 19605 USA | 1-800-523-8446 1-610-378-0131 | 8 a.m. - 8 p.m. EST | www.arrowintl.com

STERILE EO

A-06041-106A (8/15)

ARROW[®]
INTERNATIONAL